

KFK

Duct DX cooling units for rectangular air ducts

Use

- Supply air cooling for ventilation systems in various premises.
- Suitable for installation into supply or air handling units to provide air cooling.



Design

- Galvanized steel casing.
- The cooling elements are made of copper tubes and aluminum plates.
- Available in three-coil modifications and rated for operation with R123, R134a, R152a, R404a, R407c, R410a, R507, R12, R22, R32 refrigerants.
- Polypropylene droplet separator and drain pan for condensate drainage and removal included.
- Droplet separator operates efficiently at air flow below 4 m/s.

Mounting

- Only horizontal mounting by means of flanged connection. Condensate drainage must be provided.
- Air filter must be installed upstream of the cooling unit to prevent the unit soiling.
- Mounting position must ensure uniform air flow distribution through the entire cross section.
- Installation upstream or downstream of the supply fan. The minimum air duct length downstream of the fan must be 1–1.5 m to ensure air flow stabilization.
- The maximum cooling capacity is attained if the cooling unit is connected on counter-flow basis. The attached charts are valid for counter-flow connection.
- While mounting the cooling unit provide condensate drainage through the U-trap. The U-trap height must be selected with respect to the total fan pressure, refer to the table and diagram below.

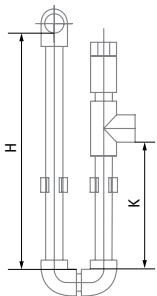

H [mm]	K [mm]	P [Pa]
100	55	600
200	105	1100
260	140	1400

H: U-trap height
K: drainage height
P: Total fan pressure

- For a proper and safe operation of the cooling unit it should be connected to a control system for integral control and automatic cooling capacity regulation.

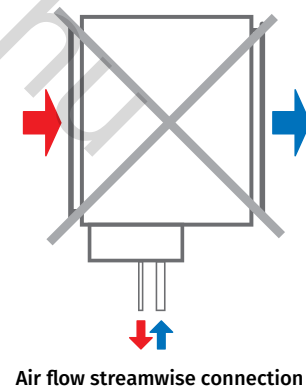
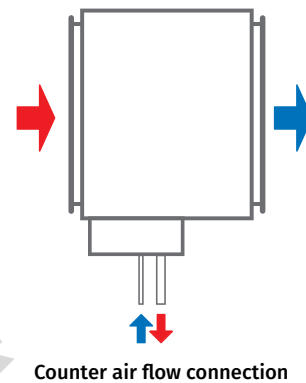

Designation key

Series	Flange size (WxH) [cm]	Number of water (glycol) coil rows
KFK	40x20; 50x25; 50x30; 60x30; 60x35; 70x40; 80x50; 90x50; 100x50	- 3

Overall dimensions [mm]

Model	Ø D1	Ø D2	B	B1	B2	H	H1	H2	L
KFK 40x20-3	12	22	400	440	470	200	295	103	44
KFK 50x25-3	12	22	500	540	570	250	345	155	44
KFK 50x30-3	12	22	500	540	570	300	395	210	33
KFK 60x30-3	18	28	600	640	670	300	395	199	44
KFK 60x35-3	18	28	600	640	670	350	445	199	44
KFK 70x40-3	22	28	700	740	770	400	495	224	44
KFK 80x50-3	22	28	800	840	870	500	595	340	44
KFK 90x50-3	22	28	900	940	970	500	595	340	44
KFK 100x50-3	22	28	1000	1040	1070	500	595	325	44

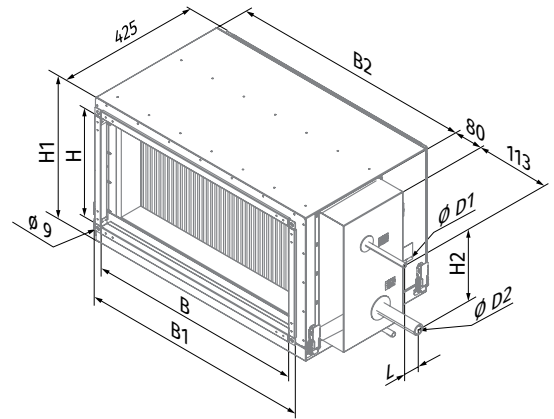

AIR PRESSURE LOSSES IN DX COOLING COILS

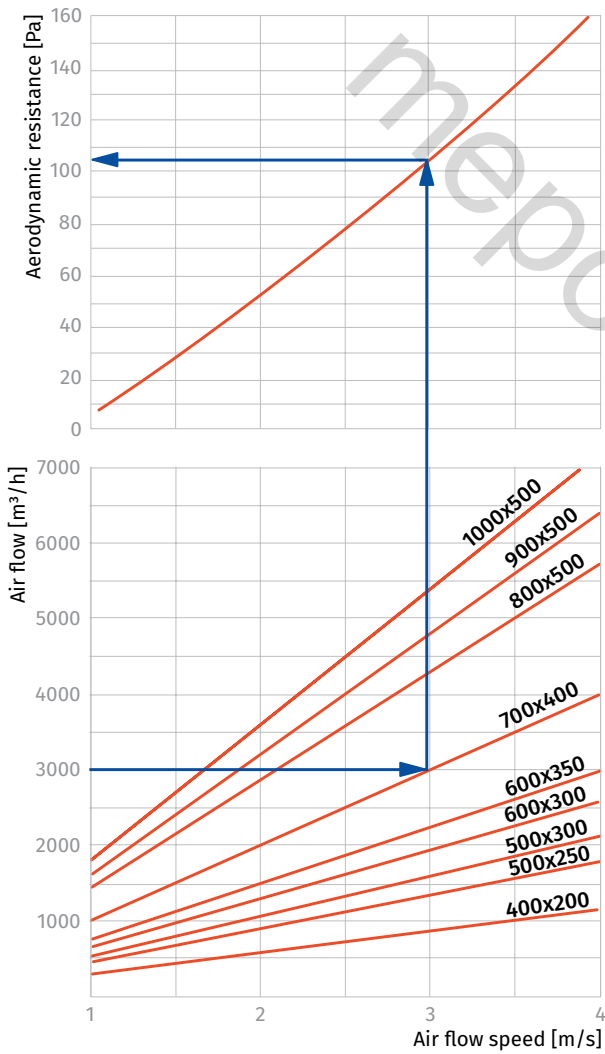

Water cooling unit calculation diagram

KFK 40x20-3

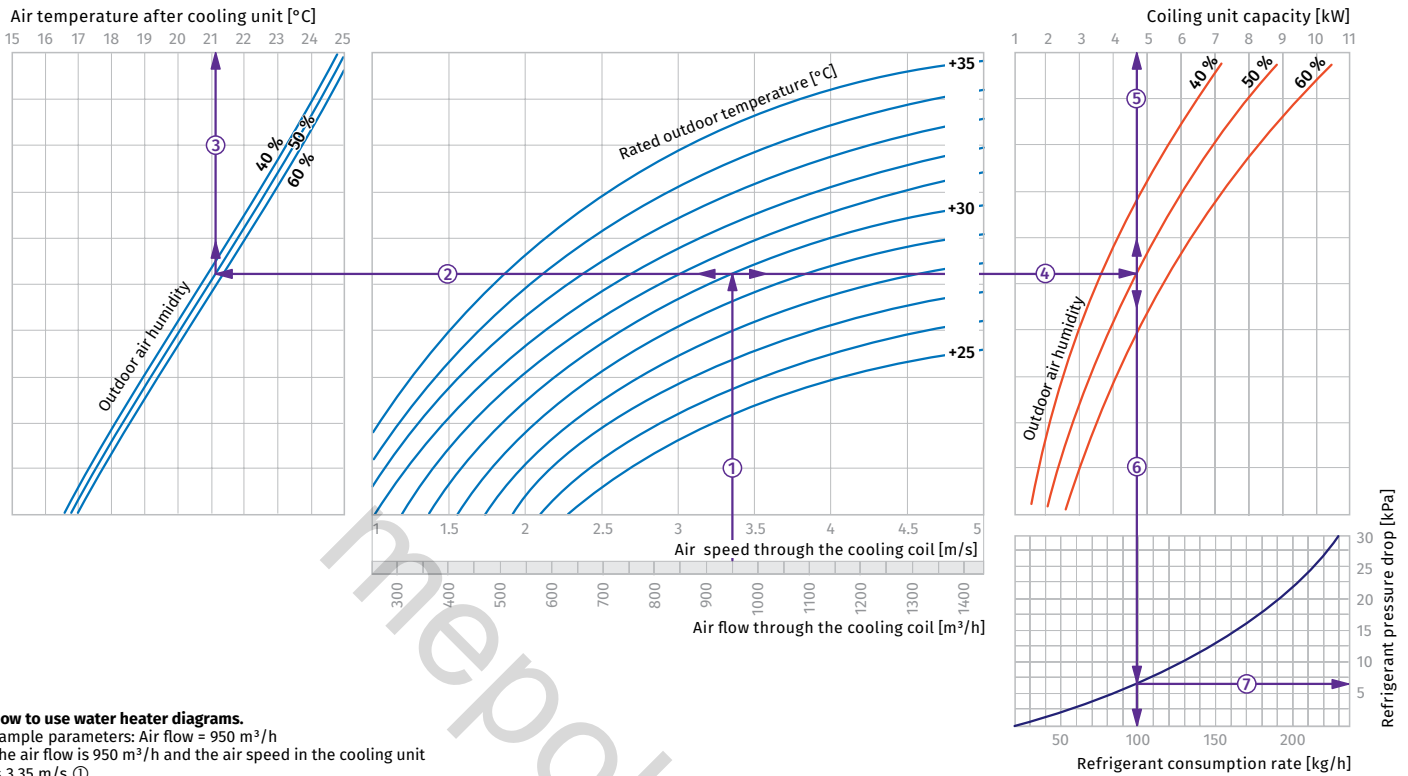

How to use water heater diagrams.

Sample parameters: Air flow = 950 m³/h
The air flow is 950 m³/h and the air speed in the cooling unit is 3.35 m/s ①.

- To calculate the coldest air temperature find the intersection point of the air flow line ① with the rated outdoor summer temperature shown in blue line (e.g., +30 °C) and draw the line ② to the left until it crosses the outdoor air humidity curve (e.g. 50 %). From this point draw a vertical line to the supply air temperature downstream of the cooling unit (+21.1 °C) ③.

- To calculate the power of the cooling unit find the intersection point of the air flow ① with the rated summer temperature (e.g., +30 °C) and draw the line ④ to the right until it crosses the air humidity curve (e.g., 50 %). From this point draw a vertical line to the cooling unit power axis (4.7 kW) ⑤.

- To calculate the required water flow in the cooling unit prolong this line ⑥ downwards to the water flow axis (100 kg/h).
- To calculate the water pressure drop in the cooling unit find the intersection point of the line ⑥ with the pressure loss curve and prolong the line ⑦ to the right on the water pressure axis (6.5 kPa).

KFK 50x25-3

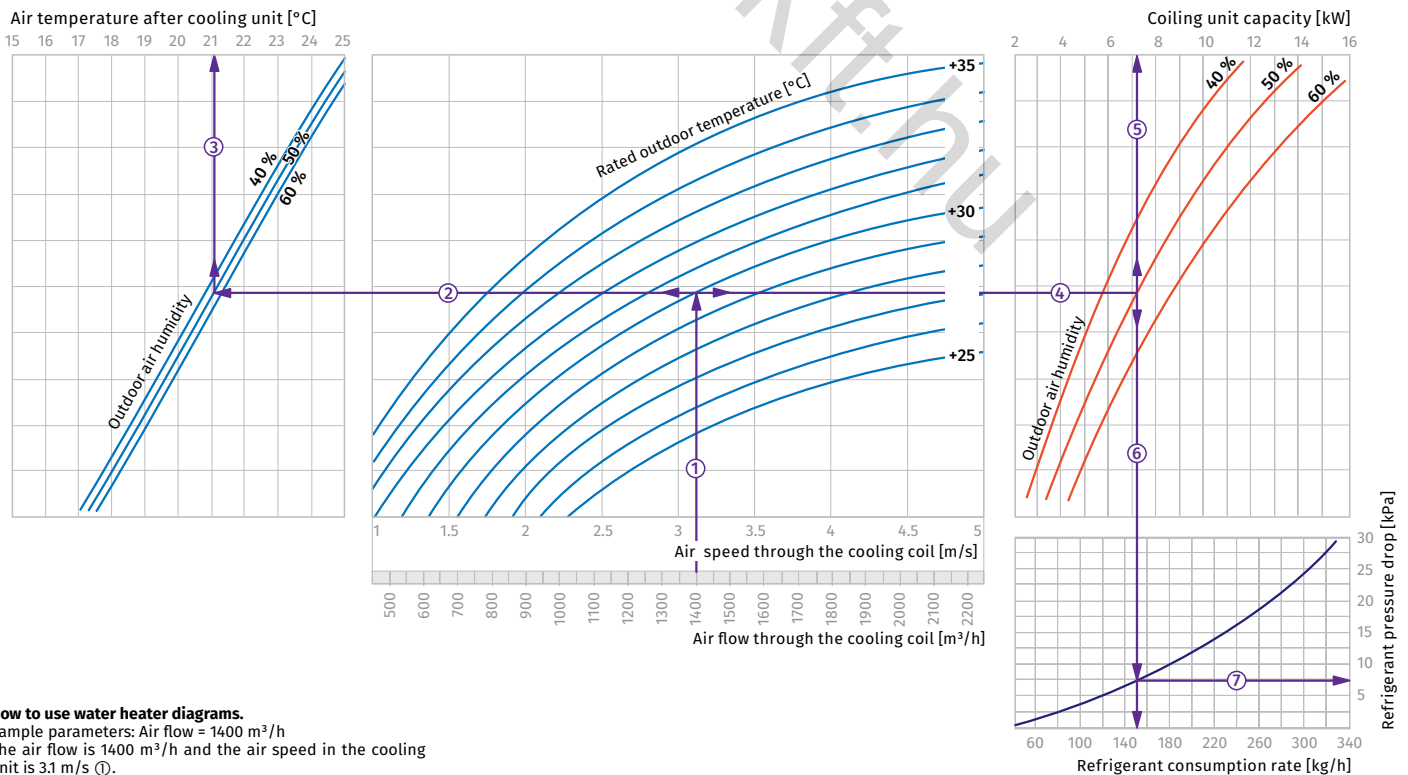

How to use water heater diagrams.

Sample parameters: Air flow = 1400 m³/h
The air flow is 1400 m³/h and the air speed in the cooling unit is 3.1 m/s ①.

- To calculate the coldest air temperature find the intersection point of the air flow line ① with the rated outdoor summer temperature shown in blue line (e.g., +30 °C) and draw the line ② to the left until it crosses the outdoor air humidity curve (e.g. 50 %). From this point draw a vertical line to the supply air temperature downstream of the cooling unit (+21.1 °C) ③.

- To calculate the power of the cooling unit find the intersection point of the air flow ① with the rated summer temperature (e.g., +30 °C) and draw the line ④ to the right until it crosses the air humidity curve (e.g., 50 %). From this point draw a vertical line to the cooling unit power axis (7.2 kW) ⑤.

- To calculate the required water flow in the cooling unit prolong this line ⑥ downwards to the water flow axis (152 kg/h).
- To calculate the water pressure drop in the cooling unit find the intersection point of the line ⑥ with the pressure loss curve and prolong the line ⑦ to the right on the water pressure axis (7.5 kPa).

KFK 50x30-3

Air temperature after cooling unit [°C]

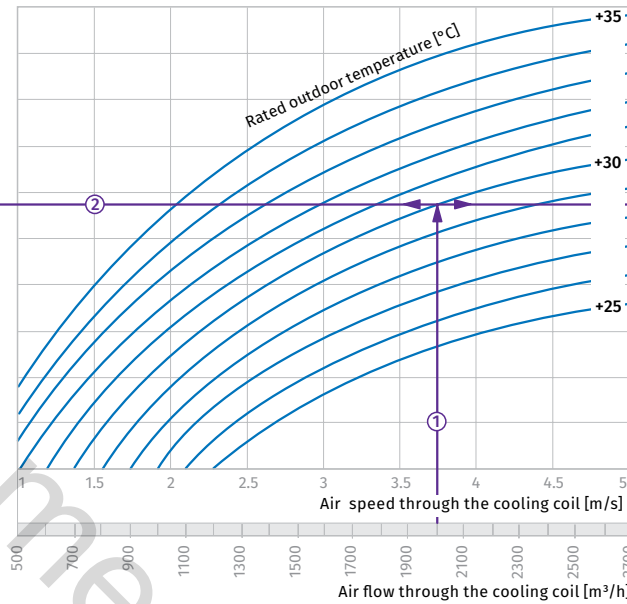
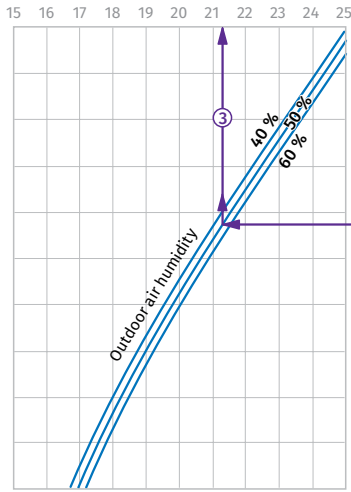

Coiling unit capacity [kW]

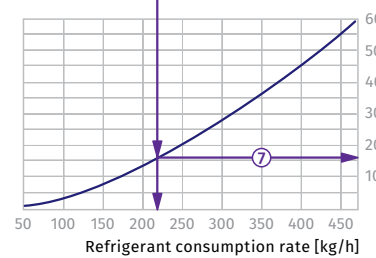
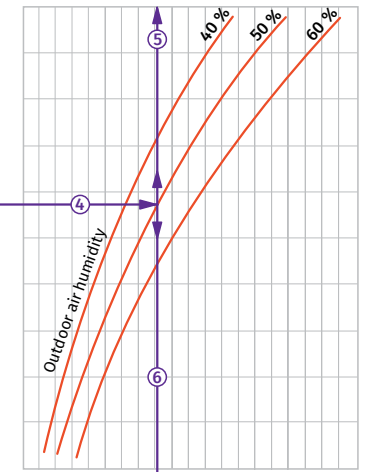

How to use water heater diagrams.

Sample parameters: Air flow = 2000 m³/h
The air flow is 2000 m³/h and the air speed in the cooling unit is 3.75 m/s ①.

- To calculate the coldest air temperature find the intersection point of the air flow line ① with the rated outer summer temperature shown in blue line (e.g., +30 °C) and draw the line ② to the left until it crosses the outdoor air humidity curve (e.g. 50 %). From this point draw a vertical line to the supply air temperature downstream of the cooling unit (+21.2 °C) ③.

- To calculate the power of the cooling unit find the intersection point of the air flow ① with the rated summer temperature (e.g., +30 °C) and draw the line ④ to the right until it crosses the air humidity curve (e.g. 50 %). From this point draw a vertical line to the cooling unit power axis (10 kW) ⑤.

- To calculate the required water flow in the cooling unit prolong this line ⑥ downwards to the water flow axis (215 kg/h).
- To calculate the water pressure drop in the cooling unit find the intersection point of the line ⑥ with the pressure loss curve and prolong the line ⑦ to the right on the water pressure axis (16.0 kPa).

KFK 60x30-3

Air temperature after cooling unit [°C]

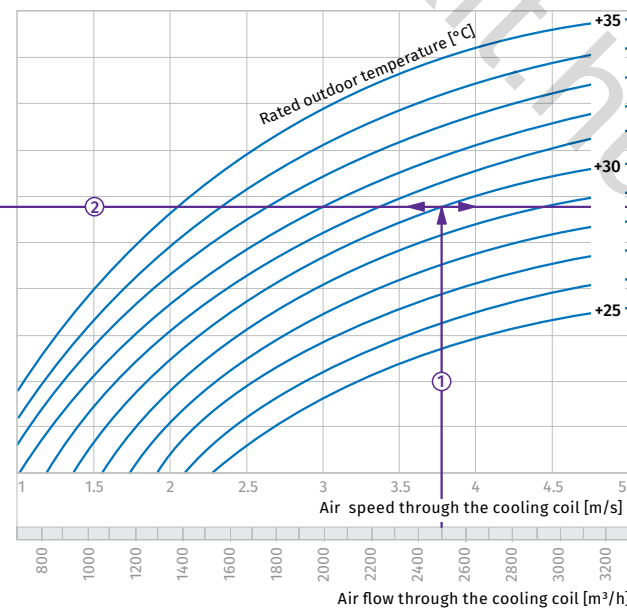
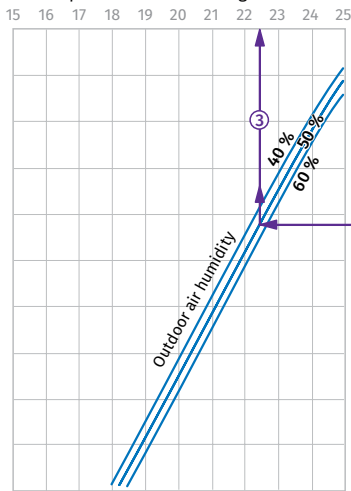

Coiling unit capacity [kW]

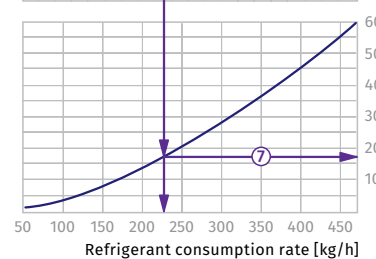
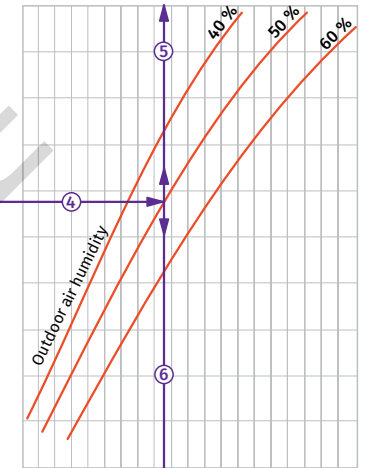

How to use water heater diagrams.

Sample parameters: Air flow = 2500 m³/h
The air flow is 2500 m³/h and the air speed in the cooling unit is 3.75 m/s ①.

- To calculate the coldest air temperature find the intersection point of the air flow line ① with the rated outer summer temperature shown in blue line (e.g., +30 °C) and draw the line ② to the left until it crosses the outdoor air humidity curve (e.g. 50 %). From this point draw a vertical line to the supply air temperature downstream of the cooling unit (+22.5 °C) ③.

- To calculate the power of the cooling unit find the intersection point of the air flow ① with the rated summer temperature (e.g., +30 °C) and draw the line ④ to the right until it crosses the air humidity curve (e.g. 50 %). From this point draw a vertical line to the cooling unit power axis (10.5 kW) ⑤.

- To calculate the required water flow in the cooling unit prolong this line ⑥ downwards to the water flow axis (225 kg/h).
- To calculate the water pressure drop in the cooling unit find the intersection point of the line ⑥ with the pressure loss curve and prolong the line ⑦ to the right on the water pressure axis (17.0 kPa).

KFK 60x35-3

Air temperature after cooling unit [°C]

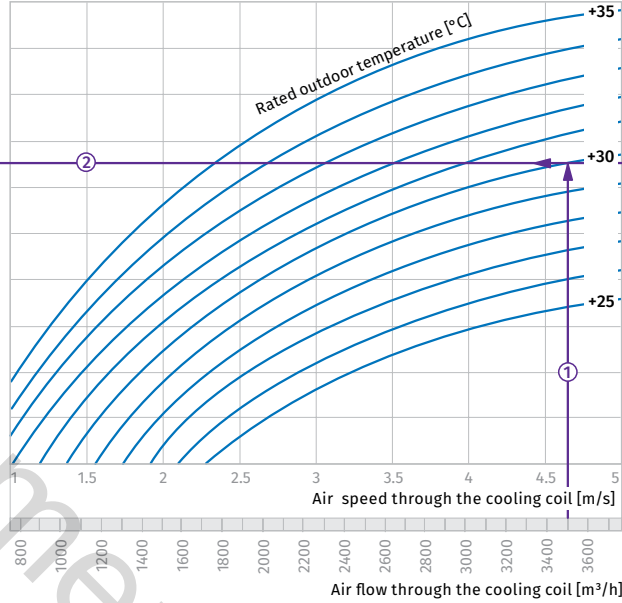
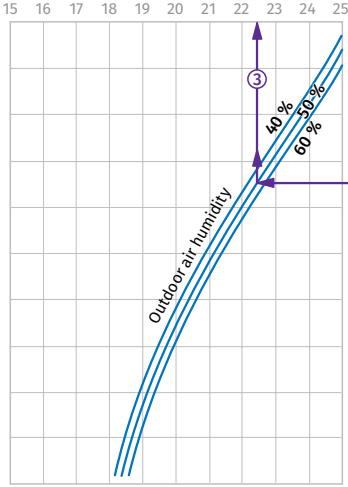

Coiling unit capacity [kW]

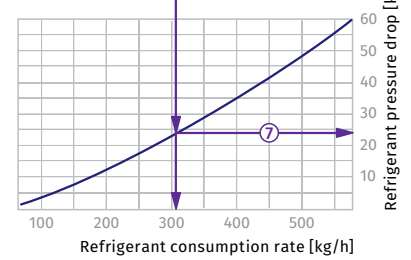
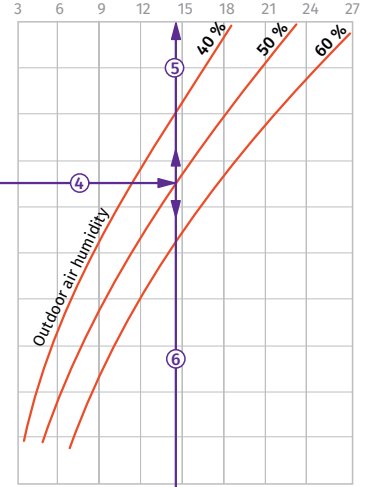

How to use water heater diagrams.

Sample parameters: Air flow = 3500 m³/h
The air flow is 3500 m³/h and the air speed in the cooling unit is 4.65 m/s ①.

- To calculate the coldest air temperature find the intersection point of the air flow line ① with the rated outer summer temperature shown in blue line (e.g., +30 °C) and draw the line ② to the left until it crosses the outdoor air humidity curve (e.g. 50 %). From this point draw a vertical line to the supply air temperature downstream of the cooling unit (+22.5 °C) ③.

- To calculate the power of the cooling unit find the intersection point of the air flow ① with the rated summer temperature (e.g., +30 °C) and draw the line ④ to the right until it crosses the air humidity curve (e.g., 50 %). From this point draw a vertical line to the cooling unit power axis (14.5 kW) ⑤.

- To calculate the required water flow in the cooling unit prolong this line ⑥ downwards to the water flow axis (310 kg/h).
- To calculate the water pressure drop in the cooling unit find the intersection point of the line ⑥ with the pressure loss curve and prolong the line ⑦ to the right on the water pressure axis (24.0 kPa).

KFK 70x40-3

Air temperature after cooling unit [°C]

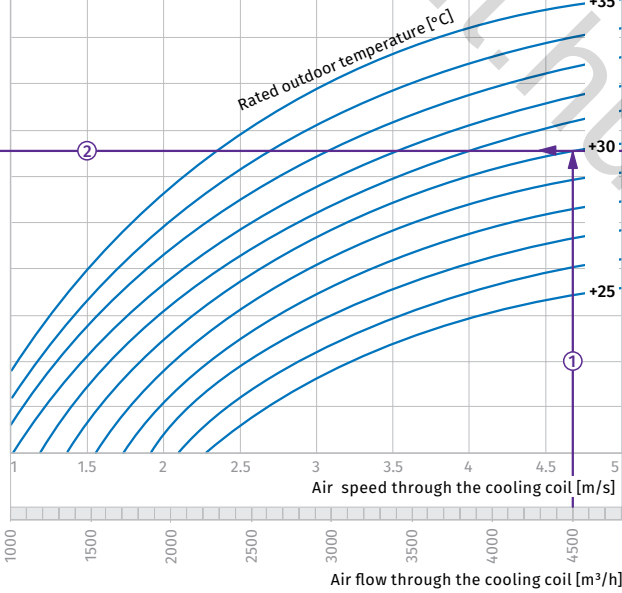
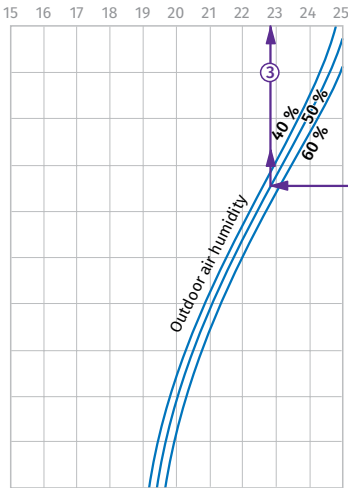

Coiling unit capacity [kW]

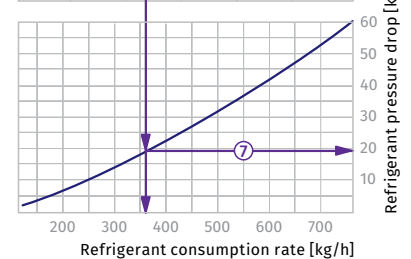
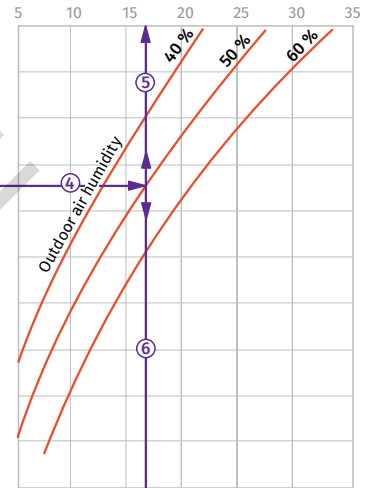

How to use water heater diagrams.

Sample parameters: Air flow = 4500 m³/h
The air flow is 4000 m³/h and the air speed in the cooling unit is 4.7 m/s ①.

- To calculate the coldest air temperature find the intersection point of the air flow line ① with the rated outer summer temperature shown in blue line (e.g., +30 °C) and draw the line ② to the left until it crosses the outdoor air humidity curve (e.g. 50 %). From this point draw a vertical line to the supply air temperature downstream of the cooling unit (+22.8 °C) ③.

- To calculate the power of the cooling unit find the intersection point of the air flow ① with the rated summer temperature (e.g., +30 °C) and draw the line ④ to the right until it crosses the air humidity curve (e.g., 50 %). From this point draw a vertical line to the cooling unit power axis (17 kW) ⑤.

- To calculate the required water flow in the cooling unit prolong this line ⑥ downwards to the water flow axis (360 kg/h).
- To calculate the water pressure drop in the cooling unit find the intersection point of the line ⑥ with the pressure loss curve and prolong the line ⑦ to the right on the water pressure axis (19.0 kPa).

COOLERS

KFK 80x50-3

Air temperature after cooling unit [°C]

15 16 17 18 19 20 21 22 23 24 25

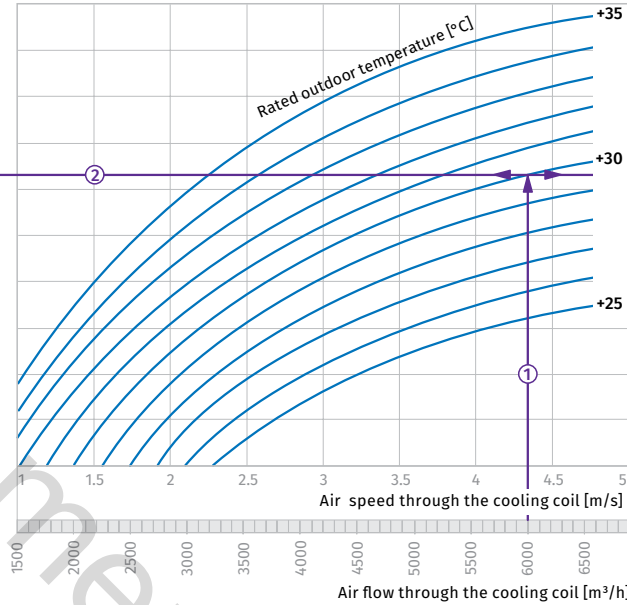
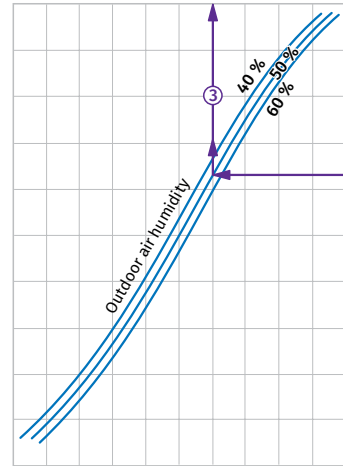

Coiling unit capacity [kW]

5 10 15 20 25 30 35 40 45

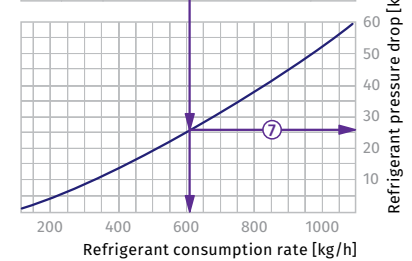
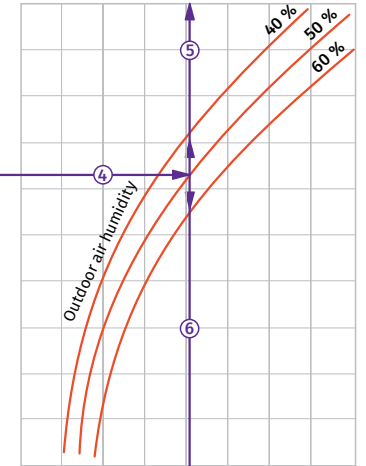

How to use water heater diagrams.

Sample parameters: Air flow = 6000 m³/h
The air flow is 6000 m³/h and the air speed in the cooling unit is 4.35 m/s ①.

- To calculate the coldest air temperature find the intersection point of the air flow line ① with the rated outer summer temperature shown in blue line (e.g., +30 °C) and draw the line ② to the left until it crosses the outdoor air humidity curve (e.g. 50 %). From this point draw a vertical line to the supply air temperature downstream of the cooling unit (+21 °C) ③.

- To calculate the power of the cooling unit find the intersection point of the air flow ① with the rated summer temperature (e.g., +30 °C) and draw the line ④ to the right until it crosses the air humidity curve (e.g., 50 %). From this point draw a vertical line to the cooling unit power axis (25.5 kW) ⑤.

- To calculate the required water flow in the cooling unit prolong this line ⑥ downwards to the water flow axis (605 kg/h).
- To calculate the water pressure drop in the cooling unit find the intersection point of the line ⑥ with the pressure loss curve and prolong the line ⑦ to the right on the water pressure axis (26.0 kPa).

KFK 90x50-3

Air temperature after cooling unit [°C]

15 16 17 18 19 20 21 22 23 24 25

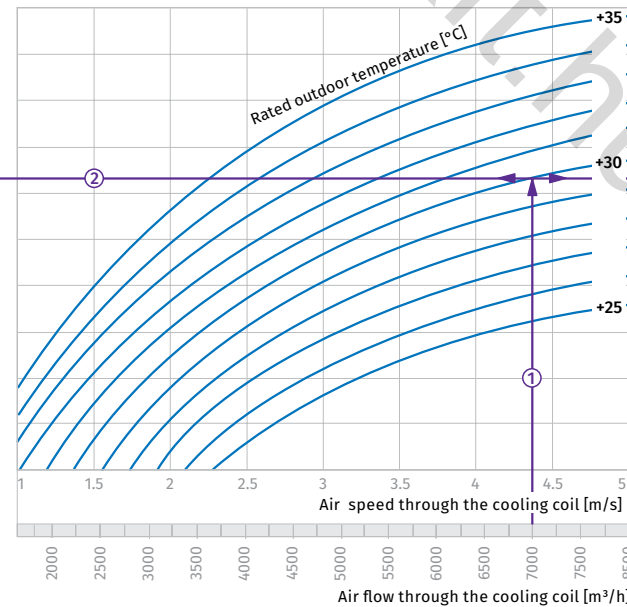
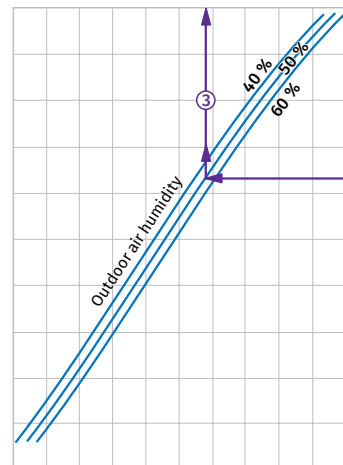

Coiling unit capacity [kW]

5 10 15 20 25 30 35 40 45 50 55

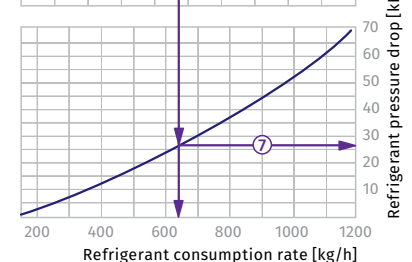
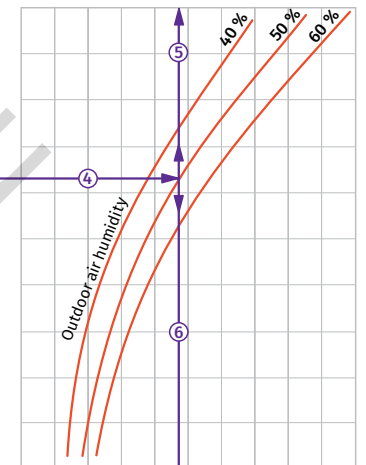

How to use water heater diagrams.

Sample parameters: Air flow = 7000 m³/h
The air flow is 7000 m³/h and the air speed in the cooling unit is 4.4 m/s ①.

- To calculate the coldest air temperature find the intersection point of the air flow line ① with the rated outer summer temperature shown in blue line (e.g., +30 °C) and draw the line ② to the left until it crosses the outdoor air humidity curve (e.g. 50 %). From this point draw a vertical line to the supply air temperature downstream of the cooling unit (+20.7 °C) ③.

- To calculate the power of the cooling unit find the intersection point of the air flow ① with the rated summer temperature (e.g., +30 °C) and draw the line ④ to the right until it crosses the air humidity curve (e.g., 50 %). From this point draw a vertical line to the cooling unit power axis (28 kW) ⑤.

- To calculate the required water flow in the cooling unit prolong this line ⑥ downwards to the water flow axis (640 kg/h).
- To calculate the water pressure drop in the cooling unit find the intersection point of the line ⑥ with the pressure loss curve and prolong the line ⑦ to the right on the water pressure axis (26.0 kPa).

KFK 100x50-3

Air temperature after cooling unit [°C]

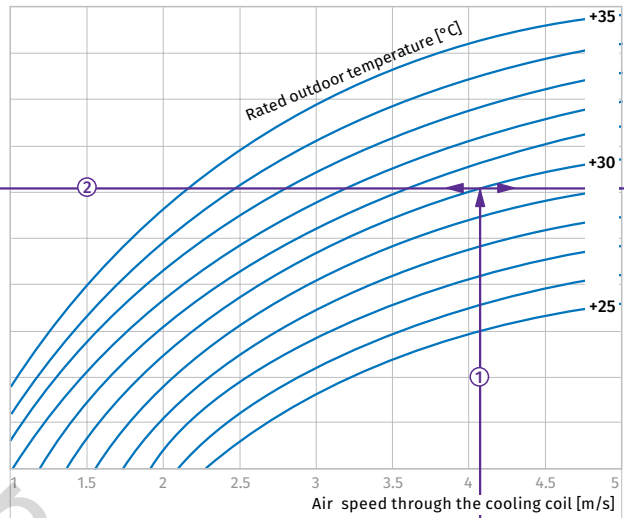
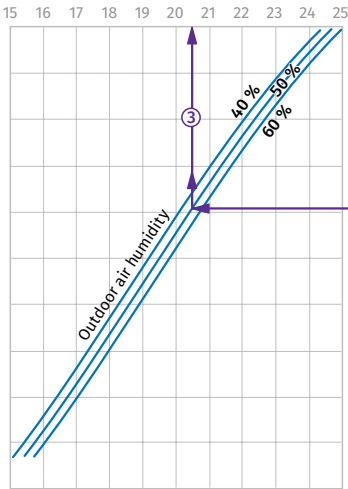

Coiling unit capacity [kW]

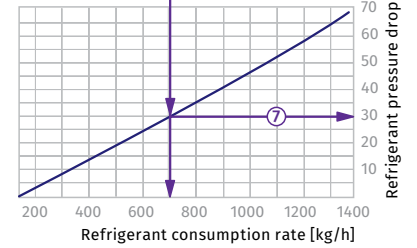
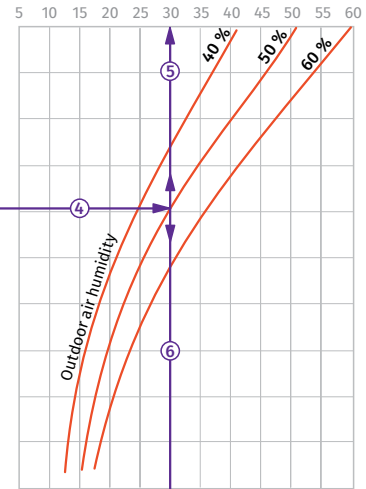

How to use water heater diagrams.

Sample parameters: Air flow = 7000 m³/h

The air flow is 7000 m³/h and the air speed in the cooling unit is 4.1 m/s ①.

- To calculate the coldest air temperature find the intersection point of the air flow line ① with the rated outer summer temperature shown in blue line (e.g., +30 °C) and draw the line ② to the left until it crosses the outdoor air humidity curve (e.g. 50 %). From this point draw a vertical line to the supply air temperature downstream of the cooling unit (+20.5 °C) ③.

- To calculate the power of the cooling unit find the intersection point of the air flow ① with the rated summer temperature (e.g., +30 °C) and draw the line ④ to the right until it crosses the air humidity curve (e.g. 50 %). From this point draw a vertical line to the cooling unit power axis (30.0 kW) ⑤.

- To calculate the required water flow in the cooling unit prolong this line ⑥ downwards to the water flow axis (710 kg/h).
- To calculate the water pressure drop in the cooling unit find the intersection point of the line ⑥ with the pressure loss curve and prolong the line ⑦ to the right on the water pressure axis (30.0 kPa).