

KOMFORT EC D5(B) 180

Heat and energy recovery air handling units

Features

- Air handling units for efficient supply and exhaust ventilation in flats, houses, cottages and other buildings.
- Heat recovery minimizes ventilation heat losses during cold season and reduce air conditioner load during hot season.
- Controllable air exchange for creating the best suitable indoor microclimate.
- Compatible with round Ø 150 mm air ducts.



Air flow:
up to 220 m³/h
61 l/s



Heat recovery efficiency:
up to 98 %



Design

- The casing is made of expanded polypropylene (EPP) 15–30 mm thick with high heat- and sound-insulating properties.
- The spigots are located at the side of the unit and are rubber sealed for airtight connection to the air ducts.

Fans

- High-efficient external rotor EC motors and centrifugal impellers with forward curved blades are used for air supply and exhaust.

- EC motors have the best power consumption to air flow ratio and meet the latest demands concerning energy saving and high-efficient ventilation.
- EC motors are featured with high performance, low noise level and totally controllable speed range.
- Dynamically balanced impellers.

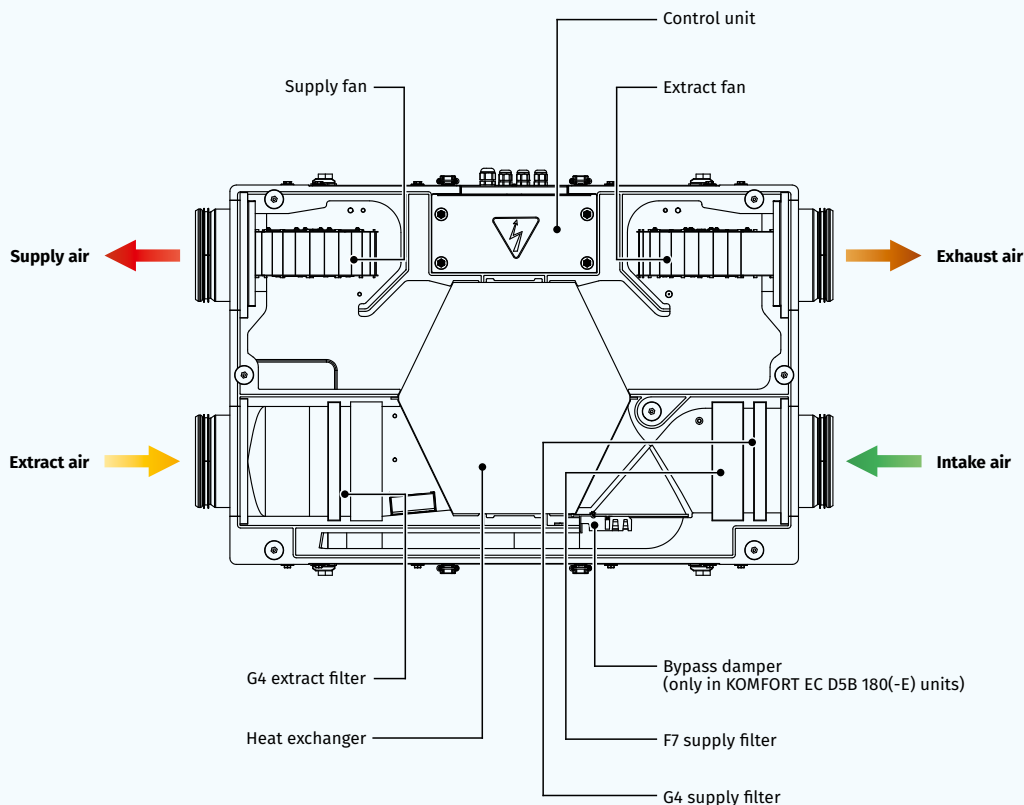

Air filtration

- Two built-in G4 and F7 filters provide efficient supply air filtration.
- The G4 filter is used for extract air filtration.

Heat recovery

- The **KOMFORT EC D5(B) 180** unit is equipped with a plate counter-flow polystyrene heat exchanger for heat recovery. The unit condensate is collected and drained to the drain pan under the heat exchanger.
- The **KOMFORT EC D5(B) 180-E** unit is equipped with an enthalpy plate counter-flow heat exchanger for energy (heat and humidity) recovery. Due to humidity recovery condensate is not generated in the enthalpy heat exchanger.

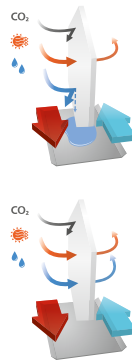

- The air flows are completely separated in the heat exchanger. Thus smells and contaminants are not transferred from the extract air to the supply air.
- Heat recovery is based on heat and/or humidity transfer through the heat exchanger plates. In the cold season supply air is heated in the heat exchanger by transferring the heat energy of warm and humid extract air to the cold fresh air. Heat recovery minimizes ventilation heat losses and heating costs respectively.
- In the warm season the heat exchanger performs reverse and intake air is cooled in the heat exchanger by the cool extract air. That reduces operation load on air conditioners and saves electricity.

Bypass

- The **KOMFORT EC D5B 180(-E)** models are equipped with a bypass which can be opened if there is a need to cool down the ventilated area with cool intake air.

Mounting

- The units are designed for suspended ceiling mounting, vertical or horizontal wall mounting.
- Sufficient service access for maintenance and filter replacement must be provided.

Control and automation

- The **KOMFORT EC D5B 180(-E) S21** units are equipped with an integrated automation system. The remote control panel is not included in the delivery set (sold separately).
- The S21 controller allows integrating the unit into the **Smart Home** system or **BMS (Building Management System)**.
- Unit control via Wi-Fi using the mobile application **Blauberg AHU**.



Download the **Blauberg AHU** app for Android





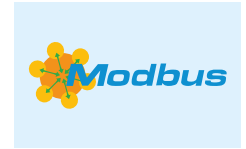

Download the **Blauberg AHU** app for iOS



- The **KOMFORT EC D5B 180(-E) S14** units are equipped with an integrated automation system and an S14 wall mounted sensor control panel with LED-indication.
- The **KOMFORT EC D5 180(-E) S2** units are equipped with a CDT E/0-10 speed regulator.

Automation functions

Functions	KOMFORT EC D5B 180(-E) S21	KOMFORT EC D5B 180(-E) S14	KOMFORT EC D5 180(-E) S2
Unit control via Wi-Fi using a mobile application	+	-	-
Unit control via a remote wired control panel	S22 control panel (option) 	S14 control panel 	CDT E/0-10 speed controller 
Unit control via a remote wireless control panel	S22 Wi-Fi control panel (option) 	-	-
Unit control via a remote wired LCD control panel	S25 control panel (option) 	-	-
BMS (Building Management System)	RS-485	-	-
	Wi-Fi	-	-
	Ethernet	-	-
	MODBUS (RTU, TCP)	-	-
Blauberg Cloud Server service	+	-	-
Speed switch	+	+	+
Filter replacement indication	by filter timer	by filter timer	-
Alarm indication	full alarm description in the mobile application	LED indication about alarms	-
Week scheduled operation	+	-	-
Bypass	automatic	-	-
	manual	manual	-
Timer	+	-	-
Boost mode	+	-	-
Fireplace mode	+	-	-
Freeze protection	using cyclical stops of the supply fan	using cyclical stops of the supply fan	using cyclical stops of the supply fan
	using preheating (option)	-	-
Reheater connection	option	-	-
Cooler connection	option	-	-
Minimum supply air temperature control	+	-	-
Humidity control	option	option	-
CO ₂ control	option	option	-
VOC control	option	-	-
PM2.5 control	option	-	-
Fire alarm sensor connection	option	option	-

Option: the functionality is available when purchasing the appropriate accessory (see the "Accessories" section)

Designation key

Series	Motor type	Spigot orientation	Casing modification	Bypass	Rated air flow [m ³ /h]	Heat exchanger type	Control
KOMFORT	EC: electronically commutated motor	D: suspended mounting, horizontally directed spigots	5: EPP	_ : without a bypass B: integrated bypass	180	_: heat recovery -E: energy recovery	S21 S14 S2

Overall dimensions [mm]

Model	∅ D	∅ D1	B	B1	B2	B3	L	L1	L2	H	H1	H2
KOMFORT EC D5(B) 180 S21/S14/S2	150	19	650	600	326	163	900	1009	302	264	110	38
KOMFORT EC D5(B) 180-E S21/S14/S2	150	-	650	600	326	163	900	1009	302	264	110	-

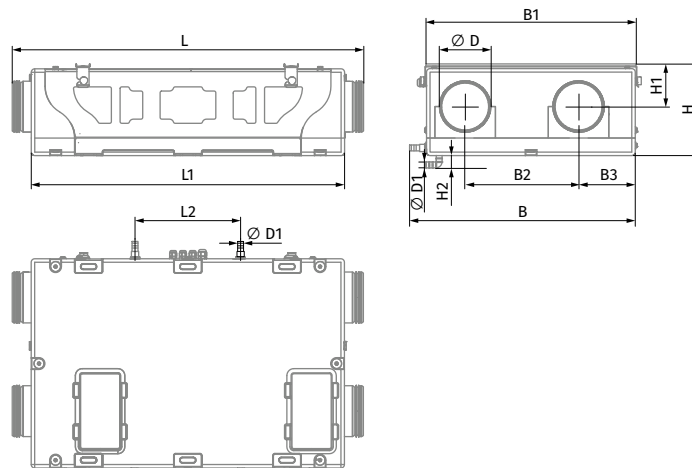

Technical data

Parameters	KOMFORT EC D5B 180 S21 KOMFORT EC D5B 180 S14 KOMFORT EC D5 180 S2	KOMFORT EC D5B 180-E S21 KOMFORT EC D5B 180-E S14 KOMFORT EC D5 180 S2
Voltage [V / 50 (60) Hz]	1 ~ 230	1 ~ 230
Power [W]	87	87
Current [A]	0.71	0.71
Maximum air flow [m³/h (l/s)]	220 (61)	220 (61)
RPM [min⁻¹]	2200	2200
Sound pressure level at 3 m [dBA]	33	33
Transported air temperature [°C]	-25...+40	-25...+40
Casing material	EPP	EPP
Insulation	15-30 mm EPP	15-30 mm EPP
Extract filter	G4	G4
Supply filter	G4+ F7	G4+F7
Connected air duct diameter [mm]	150	150
Weight [kg]	14	14
Heat recovery efficiency [%]	86-98	79-94
Heat exchanger type	counter-flow	counter-flow
Heat exchanger material	polystyrene	enthalpy
SEC class for S21 and S14 automation	A+	A+
SEC class for S2 automation	A	A
ErP	2016, 2018	2016, 2018

Sound power level, A-weighted	Total	Octave frequency band [Hz]								LpA 3 m	LpA 1 m
		63	125	250	500	1000	2000	4000	8000		
LWA to supply inlet [dBA]	59	27	46	54	55	53	48	44	35		
LWA to supply outlet [dBA]	60	27	46	54	55	53	49	44	35		
LWA to exhaust inlet [dBA]	55	25	41	50	51	44	42	39	30		
LWA to exhaust outlet [dBA]	55	26	41	51	51	44	42	39	31		
LWA to environment [dBA]	54	18	36	47	49	48	43	37	33	33	43

Data provided for point 1 of the air flow diagram

Point	Unit power [W]	Sound pressure level at 3 m (1 m) [dBA]
1	77	33 (43)
2	64	33 (43)
3	53	32 (42)
4	31	29 (39)
5	30	28 (38)
6	26	27 (37)
7	14	23 (33)
8	13	21 (31)
9	12	19 (29)

BRE

Exhaust spigot configuration	Air flow rate [l/s]	Specific fan power [W/l/s]	Heat exchange efficiency [%]
Kitchen + 1 additional wet room	21	0.90	0.88
Kitchen + 2 additional wet rooms	29	1.00	0.86
Kitchen + 3 additional wet rooms	37	1.20	0.85

Calculation of air temperature downstream of the heat exchanger:

$$t = t_{\text{outd}} + k_{\text{hr}} \times (t_{\text{extr}} - t_{\text{outd}}) / 100,$$

where







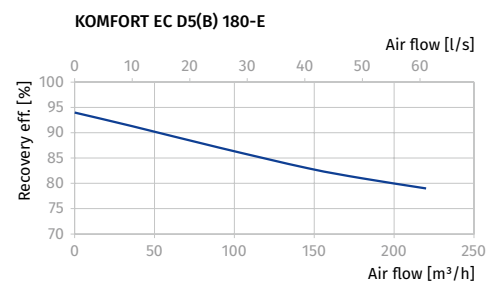
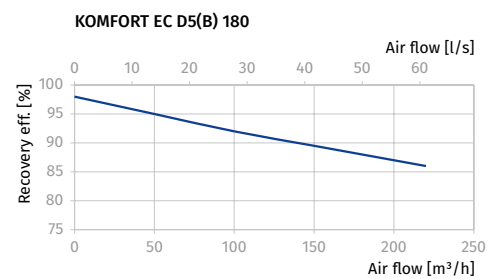
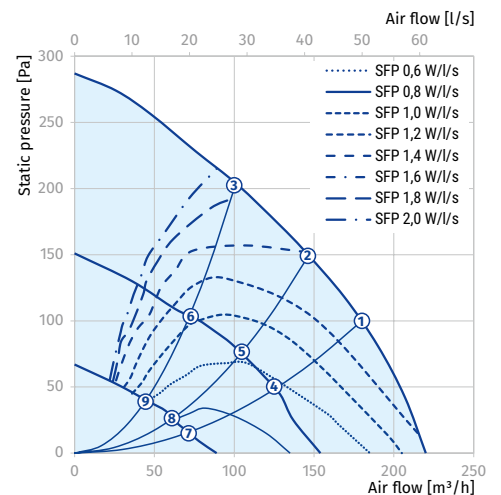











t_{outd} – outdoor air temperature [°C]





t_{extr} – extract air temperature [°C]

k_{hr} – heat exchanger efficiency (according to the diagram) [%]



Accessories

		KOMFORT EC D5(B) 180(-E) S21	KOMFORT EC D5(B) 180(-E) S14
G4 panel filter		FP 214x186x18 G4	FP 214x186x18 G4
F7 panel filter		FP 214x186x48 F7	FP 214x186x48 F7
Control panel		S22	-
Wireless control panel		S22 Wi-Fi	-
LCD control panel		S25	-
Humidity sensor		FS2	FS2
Humidity sensor		HR-S	HR-S
CO ₂ sensor		CD-2	CD-2
CO ₂ sensor with indication		CD-1	CD-1
VOC sensor		DPWQ30600	-
CO ₂ sensor		DPWQ40200	-
Humidity sensor		DPWC11200	-
Electrical preheater		EVH 150	-
Electrical reheater		ENH 150	-
Syphon kit (for the units without an enthalpy heat exchanger)		SFK 20x32	SFK 20x32
Silencer		SD 150	SD 150
Air damper		VKA 150	VKA 150
Electric actuator		LF230	LF230

KOMFORT EC D5 180(-E) S2		
G4 panel filter		FP 214x186x18 G4
F8 panel filter		FP 214x186x48 F7
Silencer		SD 150
Syphon kit (for the units without an enthalpy heat exchanger)		SFK 20x32